VPFlowScope DP

User manual

© 2019 VPI Instruments



VPFlowScope DP

© 2019 VPInstruments

All rights reserved. No parts of this document may be reproduced in any form or by any means - graphic, electronic, or mechanical, including photocopying, recording, taping, or information storage and retrieval systems - without the written permission of the publisher.

Products that are referred to in this document may be either trademarks and/or registered trademarks of the respective owners. The publisher and the author make no claim to these trademarks.

While every precaution has been taken in the preparation of this document, the publisher and the author assume no responsibility for errors or omissions, or for damages resulting from the use of information contained in this document or from the use of programs and source code that may accompany it. In no event shall the publisher and the author be liable for any loss of profit or any other commercial damage caused or alleged to have been caused directly or indirectly by this document.

Creation date: 04-07-2019 in Delft

Publisher







Van Putten Instruments BV
Buitenwatersloot 335
2614 GS Delft
The Netherlands

Table of Contents

1 Warning - Read this first	5
2 Introduction	6
3 Product overview	7
1 Configuration	7
2 VPFlowScope DP with connector cap.....	8
3 VPFlowScope DP with display.....	8
4 VPFlowScope DP with the VPFlowTerminal.....	8
4 Quick start	9
5 Measurement	10
1 Flow	10
2 Pressure	10
3 Temperature	10
4 Totalizer	10
6 Mechanical installation	11
1 Piping table	18
2 Flow range table	19
7 Display	20
1 Display status icons	20
2 LCD display	20
3 Data Logger	20
4 Keypad	21
5 Menu	21
8 VPStudio software	24
9 Electrical connections	25
1 4 .. 20 mA output	25
2 Pulse output	27
3 Modbus interface	28
10 Service	32
1 Software and firmware updates.....	32
2 Calibration interval	32
3 Filter set replacement	33
4 Service subscriptions	34

11 Specifications	35
12 Order information and accessories	36
13 Appendix A - UL	37

1 Warning - Read this first

	<p>Compressed gasses can be dangerous! Please familiarize yourself with the forces under pressurized conditions. Respect the local guidelines and regulations for working with pressurized equipment.</p>
	<p>Gas flow through pipes follows certain physical laws. These physical laws have serious consequences for the installation requirements. Familiarize yourself with these laws to make sure that the product is installed correctly. Always make sure that upstream length, downstream length, flow, pressure, temperature and humidity conditions are within specifications.</p>
	<p>Precision instruments need maintenance. Check your flow meter regularly and make sure it remains clean. When polluted, gently clean the sensor using demineralized water or cleaning alcohol. Check the internal filters and clean them when polluted or damaged.</p> <p>Precision instruments need regular re-calibration. To keep your VPFlowScope DP in best shape, it needs recalibration. We advice annual recalibration.</p>
	<p>Not intended for fiscal metering or billing. Our flow meters are not certified for fiscal metering. Laws on fiscal metering and billing may vary per country or state.</p>
	<p>Do not overestimate the results. VPIstruments does not take any responsibility for the correctness of measurement results under field conditions. The practical measurement uncertainty of a flow meter in the field may vary, depending on how well it is installed, due to the nature of gas flow. The piping table provides guidelines on how to optimize the field accuracy. Our products are not intended to be used as a single means to determine compressor capacity.</p>
	<p>Do not open the device. Our instruments are assembled with high precision. Opening this device is dangerous and may destroy the instruments. Warranty is voided when you open the instrument.</p>
	<p>Feedback leads to product improvement. Please share your experience with us, as we are continuously improving our products in our commitment to quality, reliability and ease of use. Let us know via sales@vpinstruments.com!</p>
	<p>The VPFlowScope DP is designed for use in wet air applications. It can handle 100% saturated air, where condensation may occur from time to time. However, the VPFlowScope DP is NOT a water or multiphase flow meter. A too high water content which causes flooding of the compressed air network with liquid water will cause misreadings and may damage the instrument.</p>
	<p>Stabilization time: When exposed to large pressure changes, for example during installation of the sensor, the DP sensor element needs to stabilize. This takes up to 15 minutes. During this time, readings may have a larger error.</p>

2 Introduction

Congratulations! **You purchased the easiest to use and most complete compressed air measurement tool in the world.** With the VPFlowScope DP, you can monitor and record flow, pressure, temperature, and total air consumption, simultaneously.

Great products deserve great user manuals. We have done our best to make this user manual as complete as possible. New users, please read it carefully to familiarize yourself with our products. Experienced users can check out the [Quick start chapter](#).

Check the packaging box for any inconsistencies. Should there be any shipping damage, notify the local carrier. At the same time a report should be submitted to Van Putten Instruments BV, Buitenwatersloot 335, 2614 GS DELFT, The Netherlands.

This manual is dedicated to:

VPS.R200.P4DP (VPFlowScope DP)

For latest VPStudio software and overview of latest firmware versions, please visit www.vpinstruments.com.

Older software features may not be covered by the contents of this user manual. Please contact us for a service subscription program, which includes software and firmware updates!

3 Product overview

The VPFlowScope DP measures mass flow, temperature and pressure simultaneously. All these parameters are key to proper compressed gas measurement and are therefore included in all models. With the insertion probe you are flexible in pipe diameter. All data can be accessed by Modbus RTU, 4..20mA and pulse.

The VPFlowScope DP is available in three configurations to fit every application. Use the connector cap for sensor features only, ideal for integration into a central management system. Use the display module for central read out and data logging. Use the VPFlowTerminal for central read out and data logging on location where a standard display can not be read out. For all models, all parameters and outputs are available.

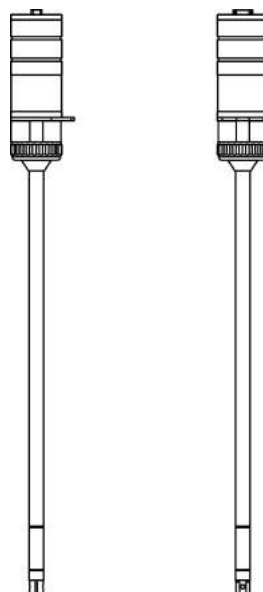

The VPFlowScope DP is available in 1 length (400 mm) only. You can choose some options:

Order Code	Flow range	Option	Length	Option	Display
VPS.R200.P4DP	20 to 200 m _n /sec	P400	400 mm length	D0	No display, No connector cap
				D10	Display
				D11	Display + 2M point logger
				D2	Connector cap

Order the VPFlowScope DP KIT to receive the complete start kit with all required accessories, everything you need to get started right away.

3.1 Configuration

The instrument needs only one step to be ready for operation. It needs to know the exact inner pipe diameter for accurate measurement, wrong inner diameter will lead to very significant errors. The pipe diameter can be programmed with the keypad on the display module or with the VPStudio configuration software. This software suite is also used for configuration of the outputs and data logger. This software can be downloaded from our website. www.vpinstruments.com/downloads.

3.2 VPFlowScope DP with connector cap

The VPFlowScope DP with connector cap can be used in applications where local read-out and data logging is not required. With its various outputs the VPFlowScope DP can be connected to remote data loggers.

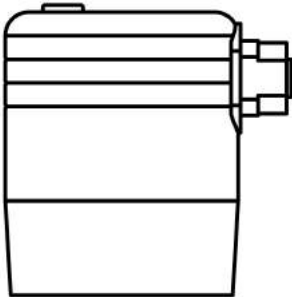

3.3 VPFlowScope DP with display

The display module adds a 3 row display with keypad and a 2 Million point data logger(optional) to the VPFlowScope DP. All parameters will be shown on the display in real time. The keypad can be used to start a data log session or to change the key parameters of the VPFlowScope DP. All output parameters for remote connection remain available on the M12 connector.

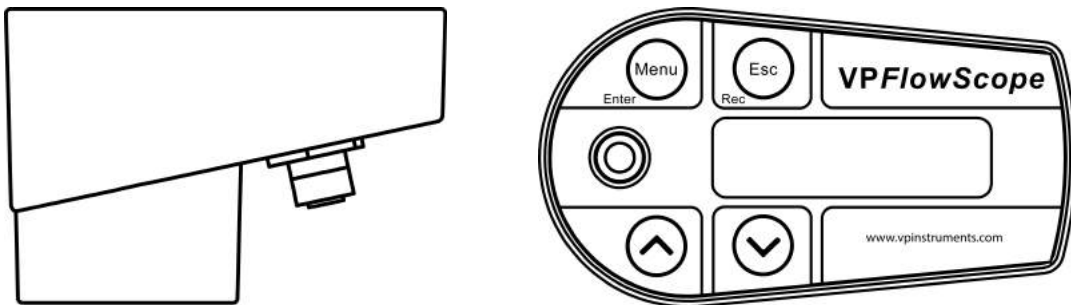

3.4 VPFlowScope DP with the VPFlowTerminal

The VPFlowTerminal can be used as a remote display for situations where the local display can't be read. All display features will be available on the remote display.

The VPFlowTerminal is equipped with a 10 m / 32.8 ft. cable and connector cap with a M12 8pin connector. The standard connector cap with M12 5pin connector can not be used for connection with the VPFlowTerminal. The VPFlowTerminal features a 2 Million point data logger which can record both the flow meter and the analog inputs.

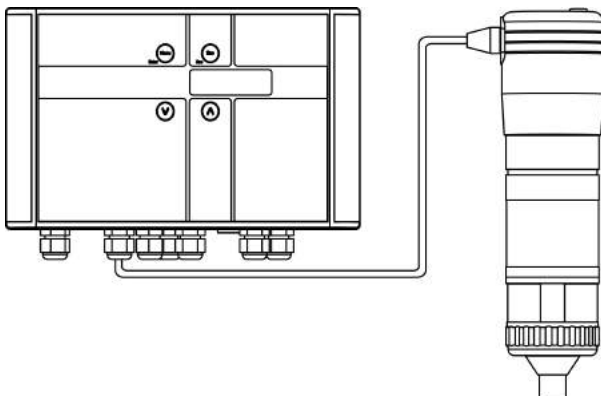

4 Quick start

This chapter contains the basic steps to start using your VPFlowScope DP flow meter. Additional information on all subjects can be found in the next chapters.

1. Unpack

Unpack the meter and check if all items are there and in good shape. A checklist with all items is available on the box.

2. Program the settings

- The inner pipe diameter needs to be programmed into the sensor. This can be done via the display or with the VPStudio software. (www.vpinstruments.com/downloads)
- If required, set the output parameters for the Modbus, pulse and current output.

3. Mechanical installation

- Find the best point of installation for this product. Make sure that all specifications are met.
- For installation of the VPFlowScope DP, an insertion point needs to be created. You can weld a tap with minimum internal 1/2 inch thread or use a hot tap saddle.
- Place a ball valve (minimal 1/2 inch full bore) and compression fitting on the insertion point.
- Connect the safety cable and insert the probe into the pipe.
- The sensor needs to be in the middle of the pipe.
- Tighten the compression fitting.

See chapter [mechanical installation](#) for more detailed information.

3. Electrical installation

3.1 Permanent installation

Connect a cable with 5 Pin M12 connector to the VPFlowScope DP. Use the power supply module for permanent installation. The cable can also be connected to a central data acquisition / building management system or data logger via Modbus, 4..20mA or pulse. See chapter [electrical connections](#) for more information.

Apply 12 .. 24 VDC to power up the device. Use a Class II power supply (less than 2 Amps). If a display is available, it will light up when power is applied.

3.2 Temporary installation

Use a 12 .. 24VDC power supply with M12 connector to power the VPFlowScope DP. This quick method is ideal for audits.

4. Data recording

When the data logger option is available a data log session can be started by pressing the esc/rec button and then enter. All parameters will be logged with the default logging intervals (5 seconds for all parameters). These logging intervals can be changed with the VPStudio software. This software tool is also used to retrieve the recorded sessions.

5 Measurement

For all parameters the update interval is 1 second. Within this second, multiple samples are taken and averaged to provide a stable and reliable output.

5.1 Flow

The VPFlowScope DP uses the differential pressure principle.

In the picture on the right, the principle is explained. Flow will create a differential pressure over the probe. This pressure is measured by the differential pressure sensor element. The gauge pressure is also measured by a separate gauge pressure sensor. The temperature sensor will measure the gas temperature. The three sensors combined provide a mass flow output.

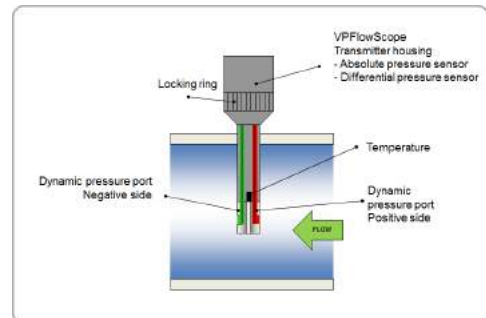

5.2 Pressure

The VPFlowScope DP features a built-in gauge pressure sensor. The sensor range is 0 .. 16 bar | 0 .. 250 psi gauge.

The sensor signal is sampled with 16 bits. The practical resolution is 0.24 mbar on the 0 .. 16 bar scale, which is equal to 0.004 psi on the 250 psi scale

5.3 Temperature

The built in temperature sensor measures the compressed air/ gas temperature. It is mounted in a separate position, to ensure quick response time.

The signal is sampled with 16 bits. The resolution is less than 0.1 °C.

For optimal measurement performance, the VPFlowScope DP needs to be in a stable temperature environment. When exposed to quick temperature changes or large temperature changes (for example taking the unit from outdoor to indoor during winter time, or when mounted downstream of a heat regenerated drier) the temperature compensation may lag behind, which may result in significant measurement errors.

5.4 Totalizer

The totalizer keeps track of the total consumed amount of compressed air in normal cubic meters, or in scf depending on which unit you choose to read out. The refresh interval is 1 second, actual measurement data will be available on the display and by Modbus. For back up reasons, the totalizer value is written to it's internal memory with an interval of 15 minutes. A power down might result in maximum 15 minutes of totalizer data loss.

In bi-directional operation, negative flow is subtracted from the totalizer. The totalizer will count backwards as the compressed air is delivered back to the supply side. The totalizer can only be reset to zero. It's not possible to set it to a different value.

The display will show totalizer values up to 999.999,9 and will then become 0,0 independent of the taken unit. This will not clear the internal totalizer.

6 Mechanical installation

Put together the VPFlowScope DP

Connect the display or connector cap on the VPFlowScope DP sensor module. Make sure that it slides completely over the O-ring seal. Position the O-ring in the upper position for the connector cap. Use the lower position for the display. Apply some O-ring grease if required. Gently fix the screw on top.

Install the VPFlowScope DP in the pipe

First select the right installation point. The installation point is crucial for the right measurements. Sources of error can be: installation effects, unknown flow profiles, swirls, pressure and temperature effects, humidity effects, oscillations in the flow. To ensure the highest possible accuracy of flow measurement, the installation and piping instructions must be followed carefully. Therefore read this paragraph carefully.

Take into account:

- Choose a site which is accessible, which allows ease of wiring and maintenance, and which allows you to still read and access the display when needed.
- Meet the specifications of the VPFlowScope DP. When the specifications are not met, for instance the pressure or temperature level is too high; this will cause inaccurate flow measurement and can even damage your flow meter.
- Do not apply mechanical stress to the flow meter.

Avoid:

- Excessive heat, check the temperature range of your VPFlowScope DP.
- Potential water damage on the outside. Avoid areas of high humidity and avoid dripping. Be aware that the VPFlowScope DP is not watertight, it is only splash proof.
- Corrosive atmosphere where possible.
- Electrical problems (high voltage/ high power).
- Mechanical vibration and danger (walking bridges, fork lift trucks).



Stop: These devices are only for use with Compressed air, non aggressive gasses and non combustible gasses. The maximum working pressure is 16 bar (250 psi)

Arrêt: Ces dispositifs sont uniquement destinés à être utilisés avec de l'air, de l'azote et d'autres gaz non dangereux et non combustibles. La pression opérationnelle maximale est de 16 bar (250 psi)

Prepare the installation

The VPFlowScope DP can be inserted through a welding tap with internal 1/2 inch thread or through a hot tap saddle. A hot tap saddle can be installed under pressurized conditions, so there is no need to shut down production.

Use a ball valve to insert and retract the VPFlowScope DP when you want. Use a 1/2 inch full bore ball valve or a 3/4 inch ball valve. The VPInstruments hot tap drill has a 1" drill size. In that case, place a 1" ball valve and use, after drilling, a reducer to go back to 1/2" for the compression fitting.



Warning: Make sure that the hole is at least 16 mm | 0.63 inch, and completely clear for insertion. A too small hole will damage the probe or can block the probe when the entering the pipe.

The installation

Select the right location. Below image shows where and where not to install the VPFlowScope DP. Location that potentially hold water should be avoided.

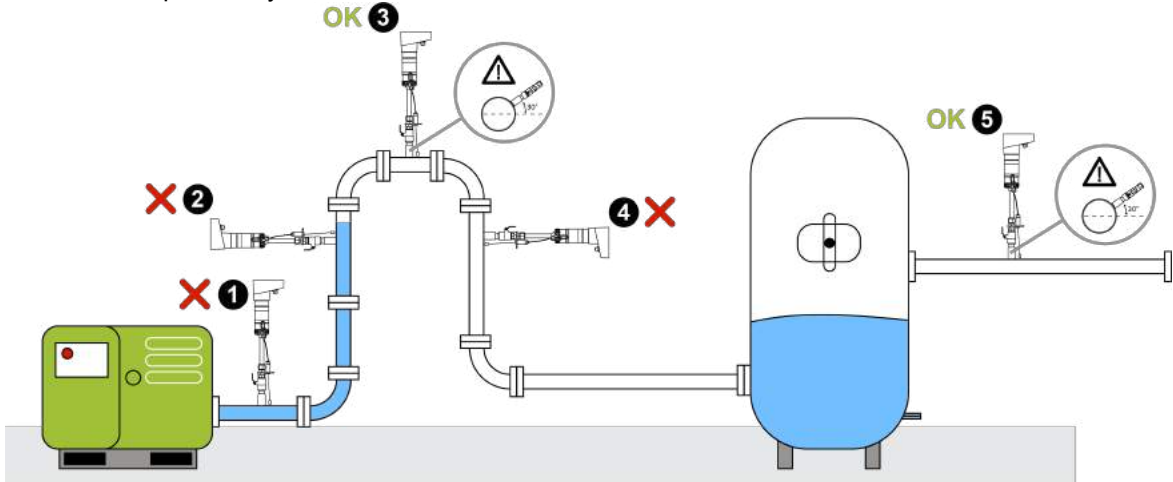

* Pipe length not to scale

We strongly advise you to carefully read, understand and follow the instructions in the table below. Not following the instruction might destroy the product.

Number	Description
1	Water might build up at the lowest point. Don't install your flow meter at this point. It will be flooded with water and eventually stop functioning properly.
2	Never install in a vertical pipe as water will stay in the negative pressure hole and cannot drain out of the instrument. It will result in reverse flow indication when the compressor stops running and/or under-reading during normal operation of the compressor.
3	The meter is installed at the highest point. Good! Water will flow to a lower point. Never install from top, as water drops down and will block the positive and negative pressure hole. This will result in false readings. Always install under an angle as indicated in the picture.
4	Never install in a vertical pipe as water will stay in the positive pressure hole and cannot drain out of the instrument. It will result in completely false readings, probably over-reading. Eventually the product will stop functioning properly.
5	The meter is installed at a high point above possible water, after the wet receiver. Excellent! The drain in the receiver will drain most water, so you will expose the flow meter mainly to mist. Make sure to install the flow meter under the indicated angle, so water can drain out properly.

Insertion depth

Generally the insertion depth of the VPFlowScope DP is 0.5 times the inner pipe diameter, where the bottom of the sensor tip must be in the middle of the pipe (see picture).

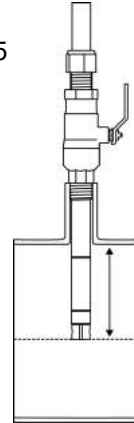

Position

ONLY Install the VPFlowScope DP upwards in an angle of 30 degrees (see picture). This enables water to drip off the probe, and the probe will be drained optimally, if any condensate is building up in the pressure tubes. Never install the instruments upside down! They will flood with water. Never install them from the top, as water drops will enter the pressure sensing holes and this causes misreadings.

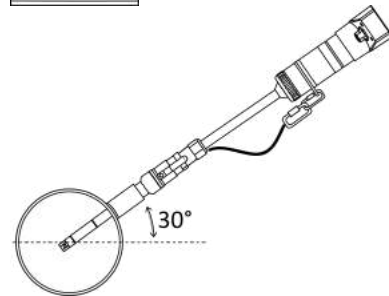

When connected to a display, the VPFlowScope DP is shaped to make alignment with the flow direction easy. The display should point downstream of the flow. With a connectorcap, the M12 connector points downstream of the flow. Alignment "by the eye" is sufficient. The flow direction is indicated on the product label.

Measurement point/ hot tap installation: make it smooth

It is important to create a smooth pipe all the way, before and after the insertion probe. This fact is often overlooked, resulting in poor measurement results. When welding a stub, and drilling the hole, make sure it is as small as possible.

Rules of thumb:

- Keep it smooth
- Avoid welding rims on the inside
- Avoid seals (from flanges) to block the flow path
- Avoid large dead spaces around the probe

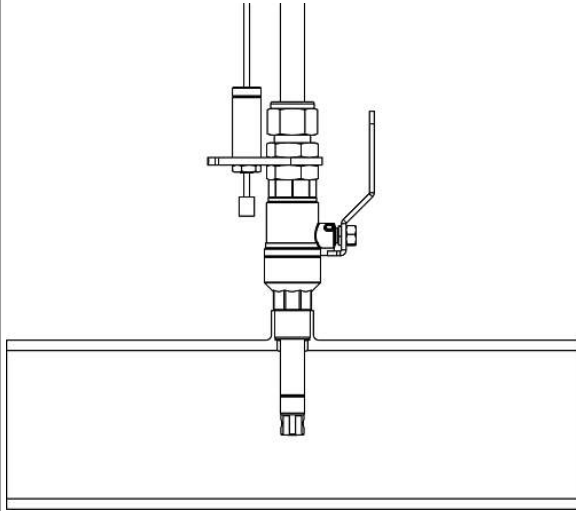
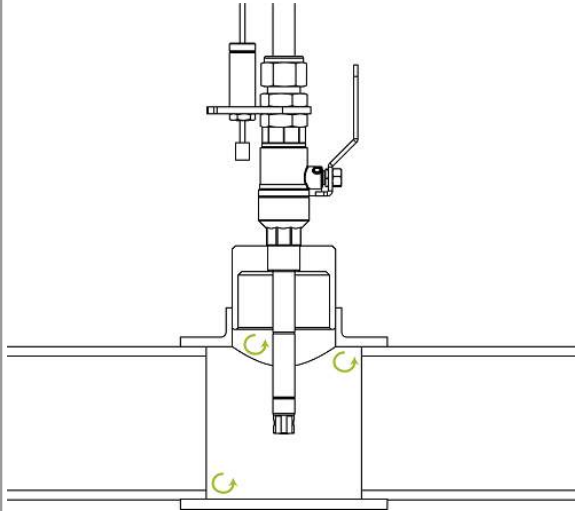
Good practice	Bad practice
	
<p>The pipe is smooth and the hole is relatively small, leaving a small gap around the sensor tip.</p>	<p>A standard T-piece is used. This causes turbulence around the sensor. Furthermore, the diameter changes in the measurement section, leading to unpredictable behavior of the flow meter over the measurement range. Especially in small pipes < 3 inch this is a very unwanted situation.</p>

Exceptions

Between pipe sizes of 25 mm and 55 mm | 1 inch and 2 inch: be aware that the field accuracy is +/- 10%; installation errors are bigger. The insertion depth between 25 mm and 65 mm | 1 inch and 2.5 inch is also different. The VPFlowScope DP needs to be installed 5 mm | 0.2 inch from the bottom or else the temperature sensor of the VPFlowScope DP itself is outside the flow path. The sensor tip will not be in the middle of the pipe any more. The measurement value is automatically corrected for small diameters.

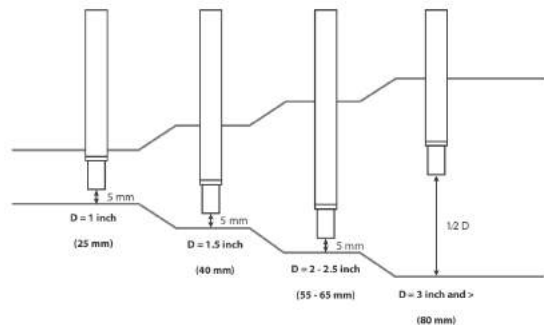



STOP

SAFETY FIRST: START WITH MOUNTING THE SAFETY LINE!

The VPFlowScope DP is mounted with a 1/2 inch compression fitting. The probe is sealed with a Teflon ferrule instead of a stainless steel ferrule. Teflon may become slippery. The safety line will keep the sensor secure when it accidentally moves out of the compression fitting. NEVER over-tight the compression fitting, because it might damage the probe.

Installation with standard safety line

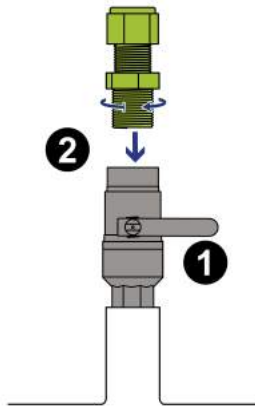

Step 1.

1. Keep the ball valve closed!
2. Insert the compression fitting in ball valve. Use Teflon tape or liquid sealant.

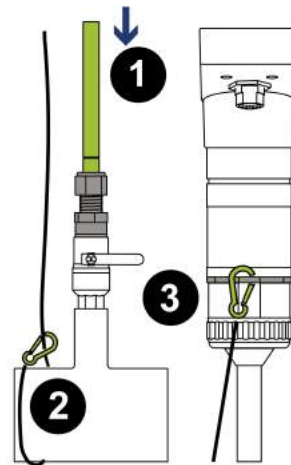

Step 2.

1. Insert the VPFlowScope DP. The probe remains in the compression fitting.
2. Attach the safety line to the pipe.
3. Hook the safety line to the ring of the VPFlowScope DP.

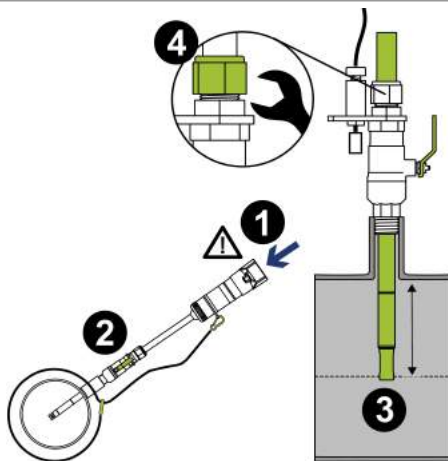

Step 3.

1. Keep your hand on top of the VPFlowScope DP.
- ⚠ When you install the VPFlowScope DP into a pressurized system you are about to experience temporary leakage and force trying to push out the VPFlowScope DP from the compression fitting. When the safety system is correctly installed this is part of the normal installation procedure.
2. Open the ball valve slowly and push the VPFlowScope DP gently downwards.
 3. The probe tip should be in the centre of the pipe
 4. Tighten the compression fitting

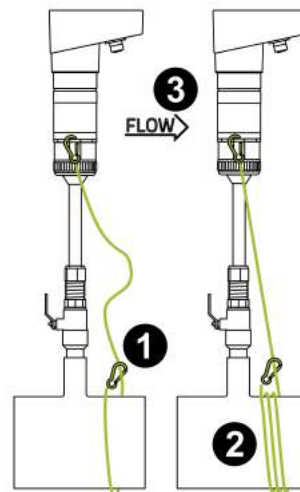

Step 4.

- Optionally pull tight the safety line. When adjusting the safety line, make sure you secure the VPFlowScope DP otherwise during adjustment. This can for example be done by applying force by hand on top of the instruments or with a secondary safety line
1. Unlock the safety line
 2. Pull tight the safety line and lock the safety line again
 3. Align the flow direction. Alignment by the eye is sufficient

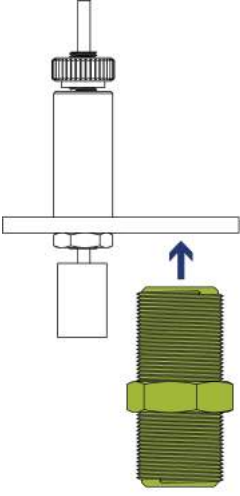
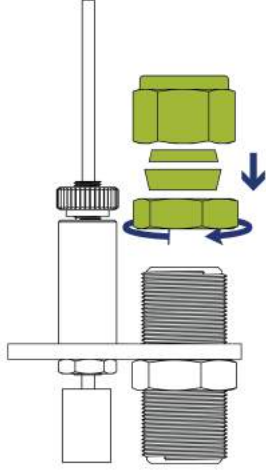
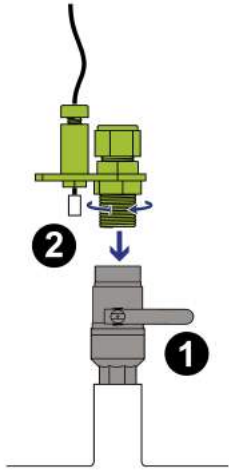
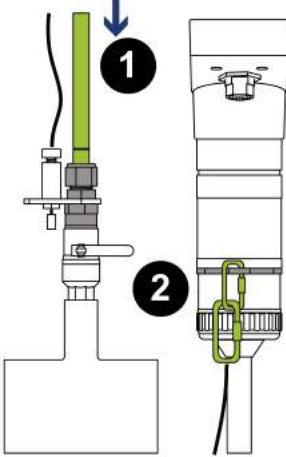
Installation with adjustable safety system	
	
<p>Step 1.</p> <ol style="list-style-type: none"> 1. Remove the compression fitting's parts on the long threaded end side 2. Place the safety plate over the compression fitting long threaded end 	<p>Step 2.</p> <ol style="list-style-type: none"> 1. Mount the nut, and close tight. Then mount the compression fitting's Teflon rings and nut
	
<p>Step 3.</p> <ol style="list-style-type: none"> 1. Keep the ball valve closed! 2. Insert the compression fitting in the ball valve. Use Teflon tape or liquid sealant. 	<p>Step 4.</p> <ol style="list-style-type: none"> 1. Insert the VPFlowScope DP. The probe remains in the compression fitting. 2. Hook the safety line to the ring of the VPFlowScope DP. Include the additional DP hook.

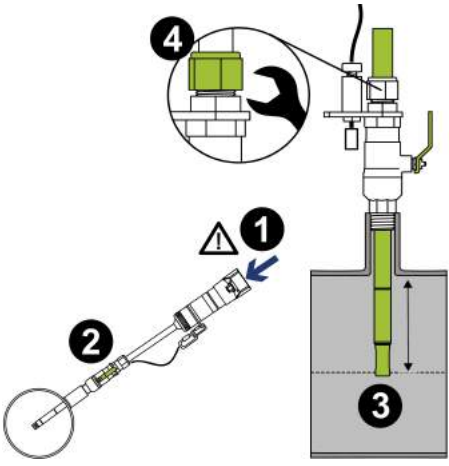
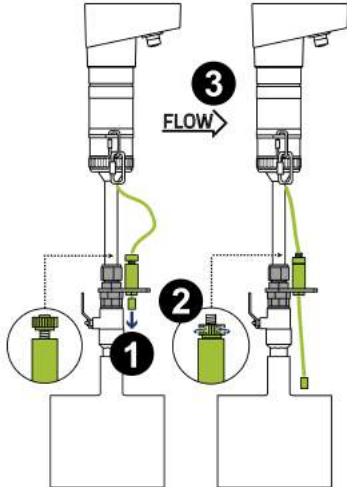
	
<p>Step 5.</p> <ol style="list-style-type: none"> 1. Keep your hand on top of the VPFlowScope DP <p>⚠ When you install the VPFlowScope DP into a pressurized system you are about to experience temporary leakage around the compression fitting and force trying to push out the VPFlowScope DP from the compression fitting. When the safety system is correctly installed this is part of the normal installation procedure.</p> <ol style="list-style-type: none"> 2. Open the ball valve slowly and push the VPFlowScope DP gently downwards. 3. The probe tip should be in the centre of the pipe 4. Tighten the compression fitting 	<p>Step 6.</p> <ol style="list-style-type: none"> 1. Unscrew the safety lock and pull the safety line tight 2. Tighten the safety lock 3. Align the flow direction. Alignment by the eye is sufficient

6.1 Piping table



Check the piping table below and follow the suggestions to get optimum results. The table shows the amount of upstream and downstream length depending on the installation. If applicable in front of the meter, use given upstream length. If applicable in behind the meter, use given downstream length. Gas flow in pipes follows certain rules, which must be observed for optimal measurement results. In some cases the upstream length needs to be longer, in other cases it can be shorter.



If possible choose a longer upstream length, as these are minimum values. The up- and downstream lengths are used industry wide as guidelines, but will never be a guarantee for obtaining the "true value". So always be careful and try to build up your own experience from practical measurements

Piping table

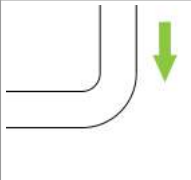
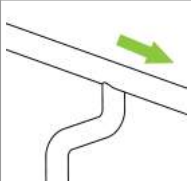
The following table provides a guideline for proper distances between upstream or downstream objects and the VPFlowScope DP. The upstream length is the length between the last non-straight object and the VPFlowScope DP. If the upstream length is straight, and the distortion is downstream of the VPFlowScope DP, you can use the column "downstream length" as a guideline. In very complex situations, with multiple up- and downstream objects, you should consider another location. This table is a practical guideline and is not exact science. Practical situations can have multiple sources of distortion, therefore VPIstruments does not take any responsibility for the correctness.

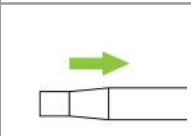
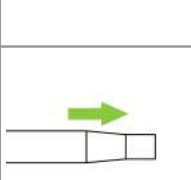
Picture	Description	Upstream length ²	Downstream length ²	Effect
	Single elbow	30 * D1	10 * D1	Distorted flow profile
	Complex feed-in situation (header)	40 * D1	10 * D1	Flow profile will be distorted
	Double elbow, multiple elbows following each other	40 * D1	10 * D1	Distorted profile + swirl
	Diameter change from small to large (gradual or instant)	40 * D1	5 * D1	Jet shaped flow
	Diameter change from large to small (gradual change, between 7 and 15 degrees)	10 * D1	5 * D1	Flattened flow profile

1 = inner diameter; 2 = minimum length

6.2 Flow range table

Schedule 40 standard seamless carbon steel pipe							
Size (inch)	DN	ID		Flow			
		Inch	mm	Min (scfm)	Max (scfm)	Min (m ³ _n /hr)	Max (m ³ _n /hr)
2	50	2.1	52.5	92	917	156	1,559
3	80	3.1	77.9	202	2,020	343	3,432
4	100	4.0	102.3	348	3,483	592	5,918
6	150	6.1	154.1	790	7,904	1,343	13,429
8	200	8.0	202.7	1,368	13,675	2,323	23,234
10	250	10.2	259.1	2,234	22,344	3,796	37,963
12	300	11.9	303.2	3,060	30,597	5,199	51,985
16	400	15.0	381.0	4,831	48,314	8,209	82,087
20	500	18.8	477.8	7,598	75,983	12,910	129,097

The ranges apply only to compressed air and nitrogen

Schedule 10 standard seamless carbon steel pipe							
Size (inch)	DN	ID		Flow			
		Inch	mm	Min scfm	Max scfm	Min m ³ _n /hr	Max m ³ _n /hr
2	50	2.2	54.8	100	1,000	170	1,698
3	80	3.3	82.8	228	2,282	388	3,877
4	100	4.3	108.2	390	3,897	662	6,620
6	150	6.4	161.5	868	8,681	1,475	14,749
8	200	8.3	211.6	1,490	14,902	2,532	25,319
10	250	10.4	264.7	2,332	23,320	3,962	39,621
12	300	12.4	314.7	3,296	32,962	5,600	56,004
16	400	15.6	396.8	5,240	52,405	8,904	89,036
20	500	19.6	496.9	8,218	82,180	13,962	139,624

The ranges apply only to compressed air and nitrogen





7 Display

The display provide some additional features:

- LCD display with 3 rows of real time data, refreshed every second
- Key pad with menu to configure the main settings
- Data logger with adjustable logging intervals (option)
- 5 custom units (multiply an existing unit with a factor and show it on the LCD display). Configuration can be done with VPStudio.

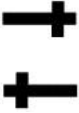
7.1 Display status icons

Some status icons show feedback on the meters' status. Below is a list with explanation

Icons	Description
	Sensor module is properly connected to the display and supplied with power
	No communication with the sensor [Check external power when disconnected]
	A blinking dot will indicate that a data session is active
	2 rotating arrows indicate that there is communication with the computer
	The display is locked. The menu can not be accessed
	Memory indication. Each block indicates 20% of memory usage. The blocks start to blink if the memory is more then 95% full

7.2 LCD display

The LCD display provides 3 rows for real time data. Each row can be configured in the display menu by selecting the desired parameter for this row. Available options are listed in [menu -> display](#).

7.3 Data Logger

The optional integrated data logger offers you 2 million data points. Enough to measure all three channels 1 x per second for more than a week. Use the following guidelines for the intervals

Application	Flow	Pressure	Temperature	Estimated log time*
Standard energy management application	5 min	5 min	5 min	2314 days
Machine testing - quick fluctuations	1 sec	1 sec	1 sec	7 days
Audit - one week	10 sec	10 sec	5 min	113 days
Audit - one month	30 sec	30 sec	5 min	330 days

* Log time with empty data logger

Multiple sessions can be recorded on the data logger. For each time a session is started, a new session will be recorded. It's not possible to append to an existing session.

When a power failure occurs during recording, the session will be aborted. When power is restored, a new session will start automatically.

7.4 Keypad

The key pad contains 4 buttons to control the display.

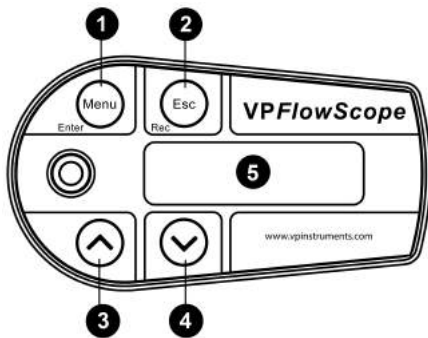

- | | | |
|---|-----------------|--|
| 1 | Menu / Enter | Used to enter the (sub)menu or to confirm a setting |
| 2 | Escape / Record | Will start a data logging session when in the data acquisition screen.
Will return from a (sub)menu when not in the data acquisition screen |
| 3 | Button up | Navigate up in the menu |
| 4 | Button down | Navigate down in the menu |

Special key functions

- Lock display

In the main screen, press up and down simultaneously to lock or unlock the display. A lock icon will appear in the right lower corner of the screen. The lock function will block keypad functionality.

- Clean re-boot.

Hold sec pressed when turning the power on. Use this option when a display will not start up or if a session won't stop. This can happen due to subsequent power failures at the moment that the memory is almost full.

7.5 Menu

The menu is categorized into 3 main items which contain their own sub menu items. The complete menu structure is shown below:

1. Settings
 1. Diameter
 2. Display
 3. Date and Time
 4. Modbus address
 5. RS485
 6. Display dim time
 7. Display orientation
2. DAQ Sessions
 1. New Session
 2. Delete all
3. Advanced
 1. Reset

1 Settings

The settings menu can be used to change both functional parameters as display settings.

1.1 Diameter

The sensor needs to know the exact inner pipe diameter to calculate mass flow. Changing the diameter is only possible when the sensor is connected. When the menu is entered, first select the desired unit, this can be in mm or inch.

Now enter the inner pipe diameter and confirm by pressing enter.

1.2 Display

The main screen of the display contains 3 rows to display measurement values. Via this menu measurement values can be assigned to these rows. Select the desired unit for row 1 and hit enter to configure row 2. Repeat the above to go to row 3. Available units are:

Measurand	Available units	Description
Empty	-	Leave this display row empty
Flow	m _n /sec m ³ _n /h l _n /min SCFM m ³ _n /min sfps	Normalized
Pressure	bar psi	Gauge
Temperature	°C °F	
Totalizer	m ³ _n	Normalized
Custom		5 available units to be configured with VPStudio. Multiply an existing unit with a user defined factor.

1.3 Date and Time

Adjust date and time settings. First enter the menu option and set the date with the key pad. The date is formatted as: DD-MM-YYYY. After setting the date, confirm with enter and then enter the time settings in format: HH:MM:SS, again confirm with enter. The new date will become active immediately.

Date/time settings are kept actual by the real time clock until long power down. Date and time will also be synchronized with the computer when used with VPStudio. Pressing the store button will trigger the synchronization.

1.4 Modbus address

The Modbus address can be changed with this option. Use the up and down buttons to change the number. Available numbers 1 – 247.

After setting the number press enter to save the address. The power of the VPFlowScope DP needs to be cycled to activate the new address.

1.5 RS485

The RS485 communication parameters baud rate, parity and stop bits can be changed in this menu.

1.6 Display dim time

The display back light dim time can be adjusted here. The default dim time is set to 10 seconds.

Other Available options are:

- Fading off. The back light will remain on.
- 5 till 30 seconds with steps of 5 seconds.

Confirming with menu will make this setting immediately active.

1.7 Display orientation

The text on the display can be rotated upside down for installations where the text needs to be mirrored. Enter the menu item and select the desired orientation with the arrow keys. Confirm with enter to make these settings active.

All keys will maintain their function.

2 DAQ Sessions

The VPFlowScope DP contains an optional 2 Million point data logger. When available, the menu is set to start and stop the sessions or to delete all present data.

2.1 Start session

The session will be started when you push the enter button after selecting this option. When the session is started, the menu will close and the main screen will be shown. A blinking dot in the right upper corner will indicate the running session. The menu will be blocked when a session is active. The session can be stopped by pressing the esc button.

2.2 Delete all

All sessions will be deleted. It is not possible to delete just a single session.

3 Advanced

3.1 Reset

Reset the device. All peripherals will be reinitialized. This option is also needed when updating the display firmware.

8 VPStudio software

The VPFlowScope DP can be read out and configured with the VPStudio software. This software can be downloaded from www.vpinstruments.com/downloads.

In case of basic configuration and read out, use the free edition. If real time data viewing and recording is required, request a license code by our sales department.

A quick start is shown below, read the VPStudio manual for more information. This manual can be downloaded from www.vpinstruments.com/downloads



The sensor module needs to be connected to the display in order to read out the display. It is not possible to read out sessions when the VPFlowScope DP sensor is not connected

Connect the VPFlowScope DP to the computer

The VPFlowScope probe can be connected to the computer with the M12 connector from the JB5 interface box. This interface box combines the power and data signals. Power up the device by connecting the 24VDC power supply to the JB5 interface box. A RS485 to USB converter can be used to connect the JB5 interface box to the computer.

Install USB converter driver

A driver needs to be installed for the RS485 to USB converter. The driver might be installed automatically by your windows system or need to be installed manually. All drivers are available on our website www.vpinstruments.com/downloads. All drivers are enclosed with the download of VPStudio and can be found in the installation folder.

Configure the VPFlowScope DP

- Start the VPStudio software
- In the explorer window, right click to open the menu. Now click add device
- Click the scan button to search for the right COM port. Select it and click add
- Enter a name for the device
- Now select serial for RS485 converter
- Set the communication parameters if available
- Click add

VPFlowScope DP sensor read out

- Click on the device in the explorer window to read out the settings
- The status tab provides general information
- The installation tab is used to configure the settings

VPFlowScope display read out

- Click on the plus icon to unfold the display icon
- Click on display to read out the display settings
- The status tab provides general information
- The installation tab is used to configure the settings
- Click sessions below display to retrieve session data

9 Electrical connections



NEVER USE AC POWER. THIS WILL VOID WARRANTY AND BRING PERMANENT DAMAGE TO THE ELECTRONICS. THE INSTRUMENT MIGHT BE DAMAGED BEYOND REPAIR.

CONNECT THE M12 CONNECTOR BEFORE POWERING UP THE INSTRUMENTS.

The VPFlowScope DP provides a 4 .. 20 mA / pulse output and a Modbus output. All signals are present in the M12 connector. These outputs can be used to connect the VPFlowScope DP to a building management system or energy monitoring system like VPVision.

Pin	Signal	Wire color*
1	+12 .. 24 VDC	Brown
2	0 Volt	White
3	4 .. 20 mA signal, active	Blue
4	RS485 B	Black
5	RS485 A	Grey

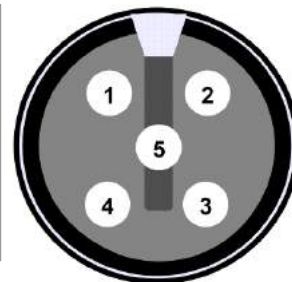

M12 5-pin female connector

* Wire colors apply to VPInstruments cables

Cabling

Shielded twisted pair cabling must be used for proper communication and measurement. Connect shield to safety ground on one point. The thickness of the wires depends on the cable length. For cabling below 300 meter | 1000 ft, use 20 awg. For longer runs use 18 awg or better.

Power supply

The input voltage is 12 to 24VDC. Make sure that the power supply is at least 12V at the connector. Voltage drops will occur in long cables resulting in insufficient power. The display will notify you when there is insufficient power.

9.1 4 .. 20 mA output

The 4 .. 20 mA output is an active, non- isolated linearized current loop that can be used to connect the VPFlowScope DP to a control system, a building/process management system or any 4 .. 20 mA based system.

There is one 4 .. 20 mA output available on the VPFlowScope DP. This output can be assigned to one of the measurement parameters, only one can be selected. For each measurand, a number of units is available. The factory default is m_n/sec .

Measurand	Unit
Flow	m_n/sec
Flow	m_n^3/hr
Flow	l_n/min
Flow	SCFM
Flow	m_n^3/min
Flow	sfps
Pressure	bar
Pressure	psi
Temperature	$^{\circ}\text{C}$
Temperature	$^{\circ}\text{F}$

For scaling purposes, the zero and span matching 4 and 20mA can be modified. This will not effect the original measurement range. The zero and span are only used to increase or narrow the resolution. For bi-directional measurement, the zero value needs to be set negative. See below table for factory defaults.

Mode	Zero	Span	Idle output
Single direction	0% flow range	100% flow range	4 mA
Bi directional	-100% flow range	100% flow range	12 mA

Configuration with VPStudio

VPStudio can be used to configure the 4 .. 20 mA settings. Use the select box to choose the preferred unit that will be assigned to the output. Set zero and span to the preferred values.

Changing to volumetric units, the programmed diameter is calculated in the settings. So change the diameter first, then the analogue settings. VPStudio provides feedback while you are changing the settings. Use "set default" to go back to the factory default.

4..20mA output

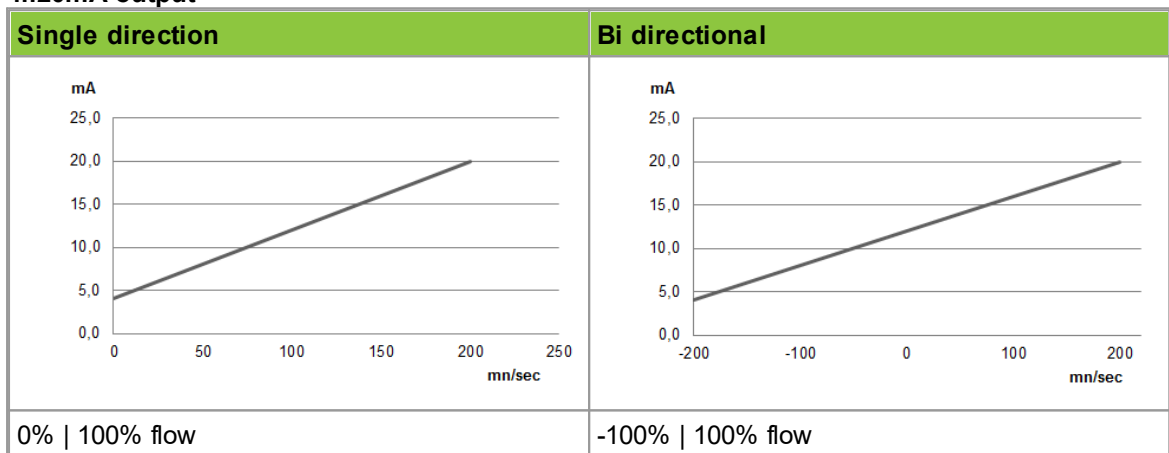

Electrical scheme:

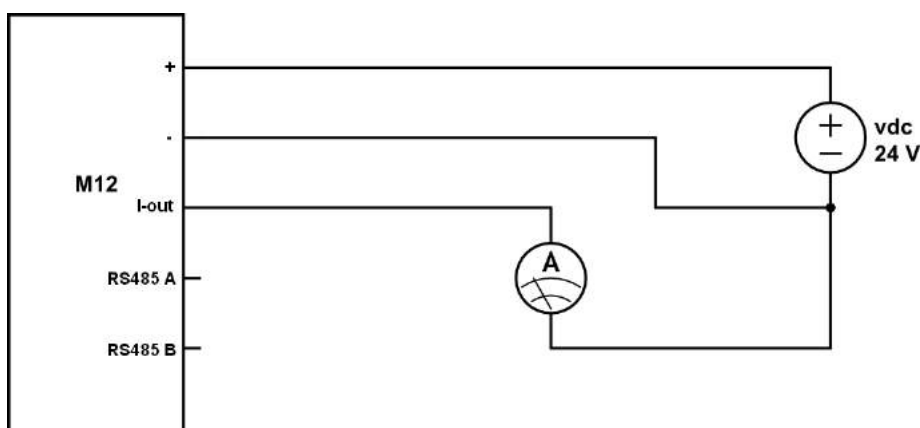

The current meter is placed in between the current output and the power supply ground. You can also use a digital multimeter to test the current output.

9.2 Pulse output

The VPFlowScope DP features a low-frequency active pulse output. The pulse is a 'non potential' free output as it acts like a controlled current output. To make it passive, an external isolator can be used.

The pulse interval can be set with the VPStudio software. A pulse from 0 .. 20 mA will be generated when the interval exceeds. The maximum pulse frequency is once per 2 seconds. If the pulse interval is set too small, a continuous pulse (20mA high level) will be the result.

The pulse output is connected to the internal totalizer value. When the totalizer has increased by the pulse interval, the pulse will be generated. As it is not possible to generate a negative pulse, negative flow can not be indicated by pulse. In case of negative flow, the internal totalizer will count backwards. Pulses will not be generated until the same amount of positive flow has been added to the totalizer again. In this way we ensure that the pulse output will always be synchronized with the internal totalizer of the VPFlowScope DP. In case of continuous negative flow, consider to change the flow meter direction.

Default settings

Diameter	Diameter	Pulse interval
> 40 mm and < 92 mm	> 1.57 inch and < 3.62 inch	1 m ³ _n
> 92 mm and < 160 mm	> 3.62 inch and < 6.3 inch	2 m ³ _n
> 160 mm and < 205 mm	> 6.3 inch and < 8.07 inch	5 m ³ _n

Pulse output

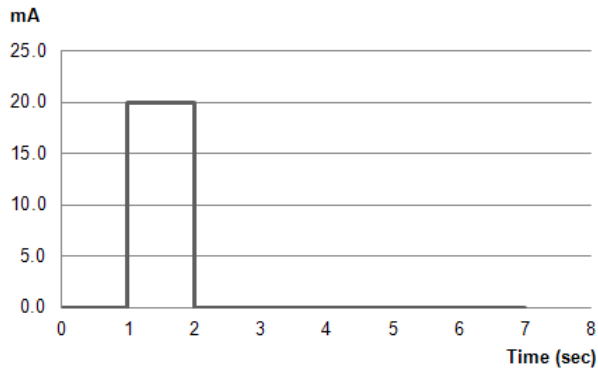

Electrical scheme:

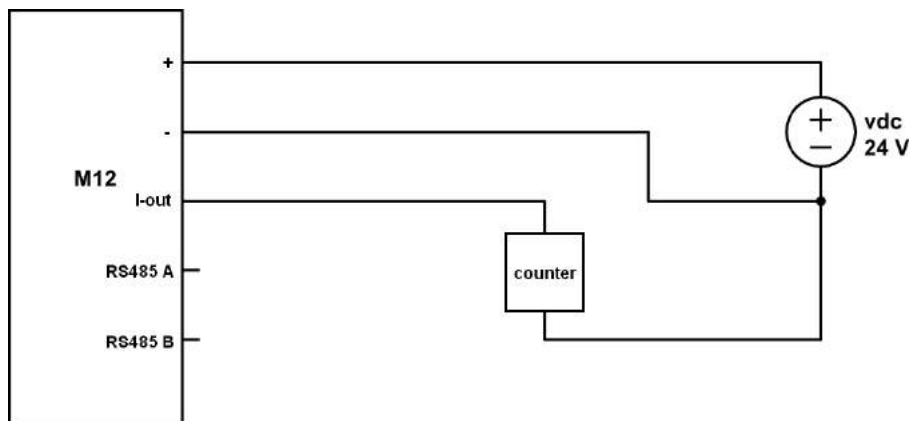

9.3 Modbus interface

Introduction to Modbus

For a complete introduction on the Modbus standard can be found on www.modbus.org. See the document `Modbus_over_serial_line_V1_02.pdf`, which can be downloaded from their website. We strongly recommend to download and read this information carefully before installing Modbus communication. The following paragraphs in this chapter assume you are familiar with the Modbus communication standard.

All measurement parameters are available through Modbus in floating point and integer format. The data will be refreshed every second. Maximum polling interval is 10ms.

Communication settings

The RS485 communication settings can be changed with VPStudio. Below shows the available options

- Baud rate: 9600 | 19200 | 38400
- Stop bits: 1 | 2
- Parity: None | Even | Odd

The Modbus settings can be changed with VPStudio, the hardware address can also be changed with the keypad when available. Below shows all available options

- Hardware address: 1-247
- Integer multiplier: 1-1000

Data format

Function code 0x03 for reading(Holding register)

Function code 0x10 for writing (Holding register)

32-bit Floating point Little endian [CDAB]

32-bit signed Integer Little endian [CDAB]

Factory default settings

Parameters	Value
Baud rate	38400
Stop bits	1
Parity	None
Hardware address	9
Integer multiplier	10

Register map

The actual measurement data is placed in holding registers. To read out data, you will need to use the corresponding holding register. All data is stored in 2 16-bit registers with below register number as start address. Read out the data with this start address and length 2.

Decimal	HEX	Description	Type	Read / Write
16	0x10	Flow in m_n /sec	32-bit integer (x10)	Read
17	0x11	Flow in m_n^3 /hr	32-bit integer (x10)	Read
18	0x12	Flow in l_n /min	32-bit integer (x10)	Read
19	0x13	Flow in SCFM	32-bit integer (x10)	Read
20	0x14	Flow in m_n^3 /min	32-bit integer (x10)	Read
21	0x15	Flow in sfps	32-bit integer (x10)	Read
32	0x20	Pressure in bar	32-bit integer (x10)	Read
33	0x21	Pressure in psi	32-bit integer (x10)	Read
64	0x40	Temperature in °C	32-bit integer (x10)	Read
65	0x41	Temperature in °F	32-bit integer (x10)	Read
128	0x80	Totalizer in m_n^3	32-bit integer (x10)	Read / Write*

* Writing to the totalizer will reset the totalizer to zero.

Decimal	HEX	Description	Type	Read / Write
8	0x08	Diameter	32-bit Floating point	Read / Write
9	0x09	4 .. 20 mA Max	32-bit Floating point	Read / Write
10	0x0A	4 .. 20 mA Min	32-bit Floating point	Read / Write
11	0x0B	4 .. 20 mA Unit	32-bit Floating point	Read / Write
24	0x18	Flow in m_n /sec	32-bit Floating point	Read
25	0x19	Flow in m_n^3 /hr	32-bit Floating point	Read
26	0x1A	Flow in l_n /min	32-bit Floating point	Read
27	0x1B	Flow in SCFM	32-bit Floating point	Read
28	0x1C	Flow in m_n^3 /min	32-bit Floating point	Read
29	0x1D	Flow in sfps	32-bit Floating point	Read
40	0x28	Pressure in bar	32-bit Floating point	Read
41	0x29	Pressure in psi	32-bit Floating point	Read
72	0x48	Temperature in °C	32-bit Floating point	Read
73	0x49	Temperature in °F	32-bit Floating point	Read
136	0x88	Totalizer in m_n^3	32-bit Floating point	Read / Write*

* Writing to the totalizer will reset the totalizer to zero.

Available write operations

Option	Data	Description
4 .. 20 mA unit	0	m_n/sec
	1	m^3_n/hr
	2	l_n/min
	3	SCFM
	4	m^3_n/min
	5	sfps
	6	bar
	7	psi
	8	$^{\circ}C$
	9	$^{\circ}F$
	Other	m_n/sec
4 .. 20 mA min	Decimal value	
4 .. 20 mA max	Decimal value	
Diameter	25 - 1016 mm	
Totalizer	Integer or floating point type depending on register type	Will reset the totalizer to zero



Installing a RS485 network require specific knowledge. Not following the specifications strictly might result in in-correct communications and equipment damage. Please leave installation up to professional contractors. Make sure that they read this chapter carefully and follow up all RS485 guidelines.

RS485 is a differential balanced line over twisted pair. It can span relatively large distances up to 1200 meter | 4000 feet. The wires should be connected as a point-to-point configuration, or also called daisy chain. Do not install as star or ring network! The trunk line goes from the master to all devices making a drop down to each device. The cable length from the trunk line to the Modbus device needs to be as small as possible. Junction boxes are used to make the T junction.

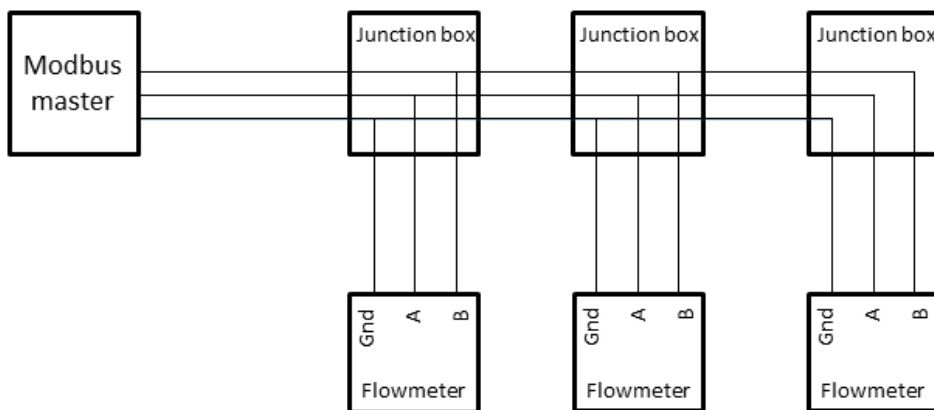

Shielded twisted pair should be used. Connection of a third wire between the master and slave should be done to limit the common mode voltage that can be impressed on the slaves inputs. The required cable quality depends on the total cable distance, the number of nodes and the environmental influences. A local contractor can help you select the right cable for your application.

Termination resistor

Termination resistors reduce electrical noise sensitivity. They need to be added to the installation when cable distances become longer than 10 meter. The value of each termination resistor should be equal to the cable characteristic impedance (typically, 120 ohms for twisted pairs).

There can only be one termination resistor at the very end of the trunk line. The VPInstruments junction box features a jumper that can be used to enable a 120 Ohm resistor. When using the VPInstruments Modbus Junction boxes make sure that the 120 Ohm resistor is only enabled in the last Modbus Junction box in the daisy chain.

Biasing

When there is no data activity on an RS485 network, the communications lines are "floating" and, thus susceptible to external noise or interference. Receivers on a RS485 network have built in hysteresis (200 mV differential required to insure known state). To insure that a receiver stays in an inactive state, when no data signal is present, bias resistors are required. Bias resistors are a pull-up resistor on Modbus B and a pull-down resistor on the Modbus A line. The value of the bias resistor depends on the number of devices and the supply voltage. The table below shows which resistor values can be used for different voltage in a chain with 1 to 8 VPFlowScope DP's.

Supply voltage	Bias pull up	Bias pull down
12 V	5 K Ω	1 K Ω
24 V	10 K Ω	1 K Ω

Bus power

The VPFlowScope DP can be powered via the same trunk line. 2 separate wires are used for power + and power -. Take in account that long wires with multiple slaves will cause voltage drops. The minimum supply voltage is 12VDC measured at the last VPFlowScope DP in the daisy chain.

Electrical scheme

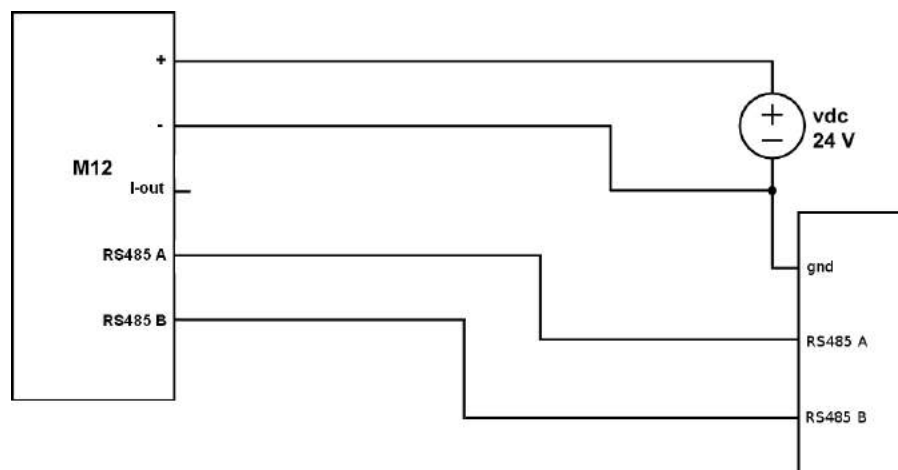

10 Service

The VPFlowScope DP needs regular maintenance to ensure that the product is functioning properly. Especially when the product is used for mobile air audits, we recommend inspecting the instrument before and after every audit to ensure that the product has not been damaged. For precision measurement equipment such as the VPFlowScope DP, a proper maintenance program is key to reliable measurement results and a long product lifetime.

10.1 Software and firmware updates

News on software and firmware updates can be found on www.vpinstruments.com, or are provided by your local re-seller. The VPFlowScope DP sensor can be updated via the RS485 port. A special display update cable is used for updating the firmware of the display. This cable is available on request. Do not use a standard cable as this might damage your display or computer. Instructions on the update procedure are distributed on request. Upgrading is only possible for authorized technicians, at own risk.

10.2 Calibration interval

The quality of the compressed air or gas you are measuring could influence the accuracy of this product. VPInstruments guarantees the accuracy, as indicated on the calibration certificate or in the product specifications when the product is used within specifications. This accuracy will remain valid until the moment of commissioning within the first 36 months after purchasing this product under the following conditions:

- The products is stored indoors in a dry, frost free environment.
- Vibrations and heavy shocks should be avoided during transport and storage.

If this product is not commissioned within 36 months after the initial purchase we highly recommend to send the product back to VPInstruments for check-up and re-calibration.

Once the product is put into operation, the calibration interval depends on the quality of the gas. If the quality of the gas is unknown, VPInstruments advises annual recalibration. The latest calibration date can be found in VPStudio.

10.3 Filter set replacement

Fixed installations:

We recommend to check the instruments initially 1 week, 4 weeks, 2 months, 4 months, 8, 12 months after the date of first installation, to check the rate of pollution on the probe and the internal filters. Service is affected by malfunctioning condensate drains inside compressors, malfunctioning oil/water separation, wrong start up, and wrong installation. After you know the rate of pollution, you can decide on the optimal maintenance interval.

Mobile use (Air Audits):

Make sure that the probe is dried out completely after the audit. Check the condition of the filters after your audit, remove excess condensate. This will prolong the lifetime of your product.

Instruction card

The following instructions can be found also with each filter replacement set.



1a. Remove sinter filter. Do not re-use!



1b. Remove filter (new style) and dispose properly



2. Inspect, and clean surface



3. Place new filter back



4. Push gently around rims



5. Place new o-rings, assemble the product

INSTRUCTIONS:

1. Check the filter condition

- Filters white and dry: OK: Continue using the VPFlowScope DP;
- Filters brown and wet/oily: NOT OK replacement is required;

2. Exchange procedure (see pictures)

1. (a) Remove both old style filters from probe and dispose. DO NOT RE-USE THE OLD FILTER. Or
(b) remove new style filter from transmitter
2. Inspect & clean surface. If dirty: remove all remains with acetone
3. Place filters back (2X)
4. With the tweezers, gently push the rims of both filters to ensure proper sticking

5. Place the o-rings back in their cavities. Make sure the o-rings are positioned properly in the probe. Do not use any grease! Assemble the unit together and apply a pressure test to make sure all seals are tight

Mobile use (Air Audits): Make sure that the probe is dried out completely after the audit. Check the condition of the filters after your audit, remove excess condensate. This will prolong the lifetime of your product.

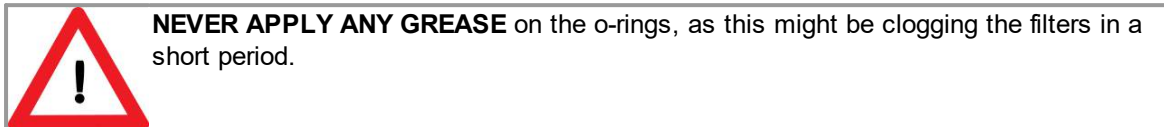

10.4 Service subscriptions

VPIInstruments offers several Service Subscriptions. Enrolling in a Service Subscription helps you get the most out of your measurement equipment. We keep your equipment in excellent and most reliable condition, as we include annual re-calibration on our calibration equipment. With the latest software releases and expert technical support, you will save time and money. We offer the following programs:

- Standard Service Agreement; Cleaning. Re-calibration, repair*, firmware update(s) and warranty extension when serviced within 12 months subsequent intervals.
- Service Exchange Agreement; Annual exchange of your flow meter. No service time! Have a fully calibrated flow meter 24/7, 365 days a week!

* *Repair within terms of usage, see general terms and conditions.*

The VPIInstruments service subscriptions helps keeping you focused on what matters most for your company.

Benefits

- Annual calibrated and cleaned instruments
- Warranty extension
- Software- and firmware updates
- Personal (phone) support and e-mail support by our skilled technicians

Consult your distributor for the best VPIInstruments service agreement for your business.

11 Specifications



Please always check the label of your product for the specifications.
Specifications are subject to change as we are continuously improving our products.
Please contact us to obtain the latest specification sheet.

Flow measurement

(minimum detection level and max flow rate shown)

Flow range	20 .. 200 m _n /sec	65 .. 650 sfps
Accuracy	2% of reading under calibration conditions	
Reference conditions	Recommended pipe diameter: 50mm 2 inch and up	
Gas temperature	0°C, 1013.25 mbar - DIN1343	32°F, 14.65 psi
Gases	-40 .. 150 °C -40 .. 302 °F Icing should be avoided	
	Compressed air, non aggressive gasses and non combustible gasses, 95 % non condensing gases	

Pressure sensor

Range	0 .. 16 bar gauge	0 .. 250 psi gauge
Accuracy	+/- 1.5% FSS (0 .. 60 °C)	+/- 1.5% FSS (32 .. 140 °F)

Temperature sensor

Range	-40 .. 150 °C	-40 .. 302 °F
Accuracy	+/- 1 °C	+/- 1.8 °F

Display

Technology	Liquid crystal
Back light	Blue with auto power save
Memory	2.000.000 point memory

Mechanical

Probe length	400 mm	15.7 inch
Probe diameter	12.7 mm	0.5 inch
Process connection	Compression fittings, 0.5 inch, NPT thread	
IP grade	IP52 when mated to display module IP63 when mated to connector cap	
Wetted materials	Alu, SS316	
Ambient temperature	0 .. 60 °C	32 .. 140 °F
Ambient humidity	10 - 95 %. Avoid condensation at all times	

Inputs and outputs

Analog	4 .. 20 mA or pulse, selectable via installation software
Serial IO	Modbus RTU
Supply	12 .. 24 VDC +/-10% CLASS 2 (UL)
Power consumption	150 mA at 24VDC

12 Order information and accessories

The VPFlowScope DP is available in 1 length (400 mm) only. You can choose some options:

Order Code	Flow range	Option	Length	Option	Display
VPS.R200	20 to 200 m _n /sec	P4DP	400 mm length	D0	No display, No connector cap
				D10	Display
				D11	Display + 2M point logger
				D2	Connector cap
				KIT	Complete audit start kit

Basic features	Display features	Connector types
Thermabridge Flow sensor	3 line display	M12, 5 pin for standard application
Pressure, temperature sensor	Keypad for configuration	
4 .. 20 mA / pulse output (switchable)	Multi session data logger	
RS485 Modbus RTU		
Calibration report		

Accessories

VPA.5000.005	Cable, 5m / 16.4 ft with M12 5pin connector on one side, open wires on other side
VPA.5000.010	Cable, 10m / 32.9 ft with M12 5pin connector on one side, open wires on other side
VPA.0000.200	Power supply (12V, 5pin)
VPA.0030.100	Power supply module in IP65 enclosure (230-110VAC to 24VDC)
VPA.5003.000	RS485 to USB converter
VPA.5001.205	JB5 interface kit with 5m / 16.4ft cable + 24 VDC power supply + RS485 to USB converter
VPA.5100.004	VPFlowScope dP set of 10 sinter filters and 10 o-rings
VPA.5100.003	VPFlowScope dP set of 24 filters and 24 o-rings
VPA.0003.006	Compression fitting for VPFlowScope 400mm dP probe with adjustable integrated safety system
VPA.5001.900	VPFlowScope connector cap with 5 pin M12
VPS.D100.000	VPFlowScope display without data logger
VPS.D110.000	VPFlowScope display with data logger
VPA.5030.020	Modbus junction box (IP65)

13 Appendix A - UL

The VPFlowScope complies with the CE requirements as stated in the CE declaration. CE compliance can only be achieved when grounding and shielding directions are followed and proper cables and connector assemblies are used.



Electrical connection guidelines- UL 508 Listing for USA & Canada (Check label to see if product is UL marked)

The VPFlowScope is intended to be used with a Class 2 power source or Class 2 transformer in accordance with UL1310 or UL1585. As an alternative a LVLC (Low Voltage Limited Current) power source, with the following properties can be used:

- The device shall be used with a suitable isolating source such that the maximum open circuit voltage potential available to the product is not more than 24 VDC and the current is limited to a value not exceeding 8 amperes measured after 1 minute of operation;
- A fuse in accordance with the UL248 series and rated max 4A, shall be installed in the 24V DC power supply to the device? In order to limit the available current.

Electrical connection guidelines: general remarks

Make sure that the following conditions are met:

- For portable, non-critical applications, a switched mode 12 VDC, 1A power adapter may be used. Switched mode power supplies that are of poor quality, might affect the accuracy.

Le VPFlowscope est conforme aux exigences CE, comme indiqué dans la déclaration CE. La conformité CE ne peut être atteinte que lorsque les directives de mise à la terre et d'isolation sont suivies et que les câbles et raccords appropriés sont utilisés.



Lignes directrices pour branchements électriques – UL508 pour le Canada et les États-Unis (voir sur l'étiquette si le produit est marqué UL)

Le VPFlowscope est prévu pour être utilisé avec une source d'alimentation Classe 2 ou avec un transformateur de Classe 2 en accord avec UL1310 ou UL1585. Comme alternative, une source d'alimentation BTCL (Basse Tension Courant Limité) avec les propriétés suivante peut être utilisée :

- Le dispositif doit être utilisé avec une source d'isolation appropriée afin que le voltage maximal en circuit ouvert disponible pour le produit ne dépasse pas 24VDC, et que le courant soit limité à une valeur de 8 ampères après 1 minute de fonctionnement.
- Un fusible de 4A maximum, et conforme à la série UL248 doit être installé dans la source d'alimentation de l'appareil afin de limiter le courant disponible.

Directives pour le raccordement électrique : remarques générales

Assurez-vous que les conditions suivantes sont remplies :

- Pour les applications mobiles, un adaptateur de type alimentation à découpage 12VDC, 1A peut-être utilisée. Cependant, un adaptateur de mauvaise qualité pourra affecter la précision.

Notes

Notes

easy insight into energy flows

VPInstruments

Buitenwatersloot 335
2614 GS Delft
The Netherlands
info@vpinstruments.com
www.vpinstruments.com

MAN-VP-SDP-EN-1902

Date: 04-07-2019



INSTRUMENTS